

Tools required: T25 Torx driver, T20 Torx driver and 8mm adjustable wrench.

Compatible with VA9104, VA9203, VA9308 and VA9310 Series actuators. For VA9208 series actuators, use field furnished #10-24 x 3 1/2" screws and two locking nuts #10-24.

### Honeywell/Siemens/Griswold

1

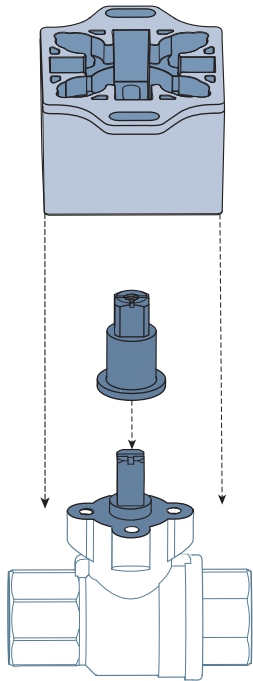

2

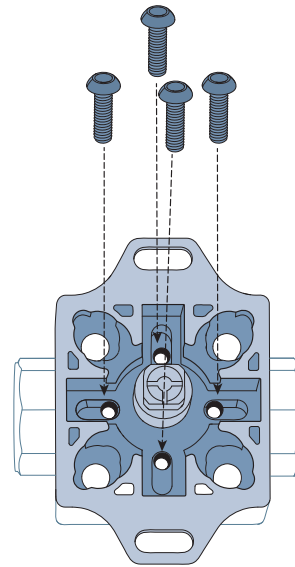

Use 14mm bolts

3

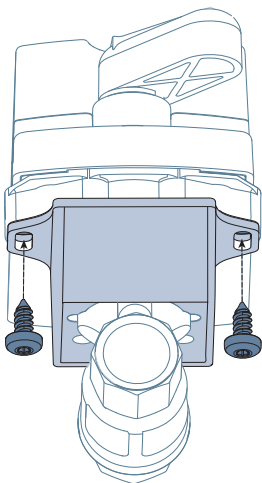

4

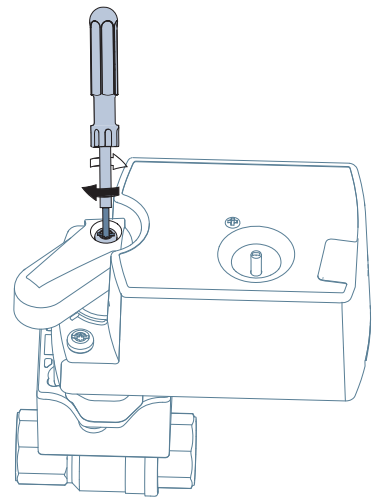

### Belimo

1

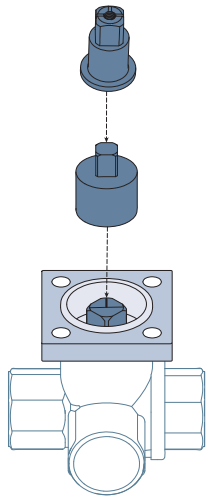

2

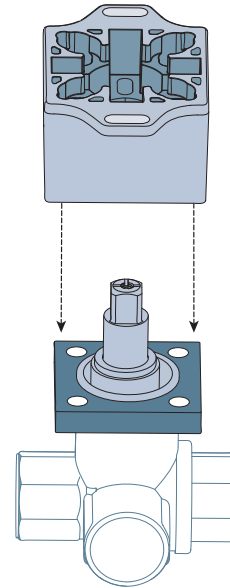

3

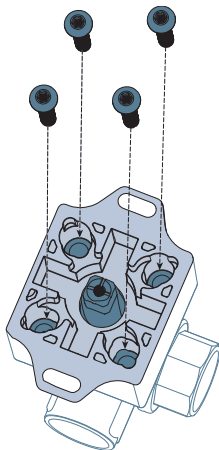

Use 25mm bolts.

4

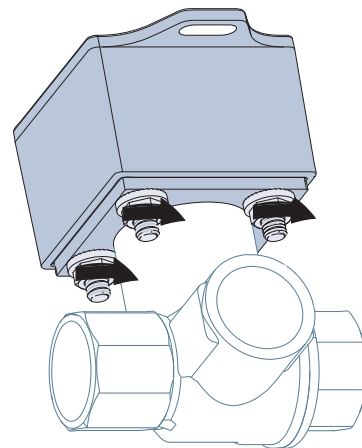

5

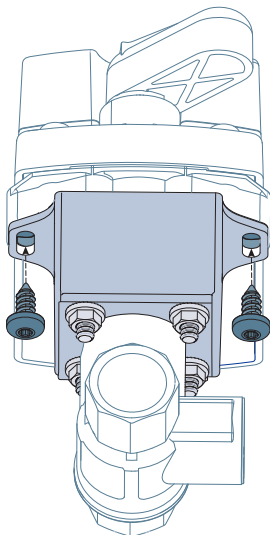

6

